

In case of discrepancies between the French and the English text,  
the French text shall prevail

**Manual of electronic transmission for  
the security by security reporting  
of credit institutions  
Balance sheet data - BBS**

**Banque centrale du Luxembourg**

## Contents

1	Introduction .....	3
2	Transmission.....	4
	2.1 Attribution of the file name.....	4
	2.2 Means of transmission .....	5
3	Visualisation of the XML schema for the security by security reporting.....	6
	3.1 Header .....	6
	3.1.1 The attributes .....	7
	3.1.2 The branch Header.....	7
	3.2 The balance sheet line .....	10
	3.2.1 Assets .....	13
	3.2.2 Liabilities .....	21
4	Format of variables in the XML file .....	29
<del>1</del>	<del>Introduction .....</del>	<del>3</del>
<del>2</del>	<del>Transmission.....</del>	<del>4</del>
	<del>2.1 Attribution of the file name.....</del>	<del>4</del>
	<del>2.2 Means of transmission .....</del>	<del>5</del>
<del>3</del>	<del>Visualisation of the XML schema for the security by security reporting.....</del>	<del>6</del>
	<del>3.1 Header .....</del>	<del>6</del>
	<del>3.1.1 The attributes .....</del>	<del>7</del>
	<del>3.1.2 The branch Header.....</del>	<del>7</del>
	<del>3.1.3 The balance sheet line.....</del>	<del>10</del>
	<del>3.1.4 Securities identified by an ISIN number .....</del>	<del>12</del>
	<del>3.1.5 Securities not identified by an ISIN number .....</del>	<del>14</del>
<del>4</del>	<del>Format of variables in the XML file .....</del>	<del>17</del>

## 1 Introduction

This manual details the technical characteristics that must be employed for the electronic transmission of the security by security reporting regarding balance sheet data of credit institutions.

The instructions concerning the data collection are described in the document “Instructions for the security by security reporting on balance sheet data of credit institutions”.

The aim of this manual is to describe the general principles of the reporting in XML format for the security by security reporting on balance sheet data of credit institutions.

The XML scheme as well as the technical documentation is available for download on the BCL's website. It is important to know that the design of the XML reporting scheme is based on a tree structure menu.

Data to be reported must not only satisfy general format checks but also inclusion into a code list. The choice of the code depends on the level of the data in the tree structure menu.

The scheme contains format constraints for the data, but it does not necessarily specify the validity of a code that respecting the format. The nomenclature as well as the verification rules defined in this manual must be respected.

## 2 Transmission

### 2.1 Attribution of the file name

The file name structure is the following:

TPTBBS\_aaaamm\_Rrrrrrrr\_Dddddddd\_aaaammdd\_nnn

where :

- TPT (*Titre Par Titre*) identifies the security by security reporting.
- BBS (Bank Balance Sheet) identifies the data relating to the balance sheet of banks.
- aaaamm represents the year and the month the data refers to.
- R identifies the type of the reporter.  
The reporter is the entity that submits the data. Banks must use the letter B.
- rrrrrrrr allows the identification of the reporter  
The identification numbers are allocated by the CSSF and/or the BCL. The digits on the left are equal to "0".  
Example: Bank 999 is identified by 000000999.
- D identifies the type of *declarant*.  
The declarant is the entity whose data is reported. Banks must use the letter B.
- dddddddd allows the identification of the *declarant*.
- The identification numbers are allocated by the CSSF and/or the BCL. The digits on the left are equal to "0".  
Example: Bank 999 is identified by 000000999.
- aaaammdd is the creation date of the file.
- nnn is the sequential number of the file.  
The sequential number of the file allows to separately identify files that are created on the same day for the same report. It should be noted that a new sequence must be started each day and that the sequential number starts at 001; thus 000 must not be used.

Example 1:

TPTBBS\_201006\_B000000999\_B000000999\_20100714\_001.xml corresponds to the first file created on 14 July 2010, submitted by bank number 999 and the data refers to bank number 999 for the period June 2010.

## 2.2 Means of transmission

The BCL accepts the use of the current electronic transmission channels offered by Cetrel and Finesti. However, the BCL is also willing to accept a new secure transmission channel that would have to be proposed jointly by both, the BCL and the reporting agents.

### 3 Visualisation of the XML schema for the security by security reporting

#### 3.1 Header

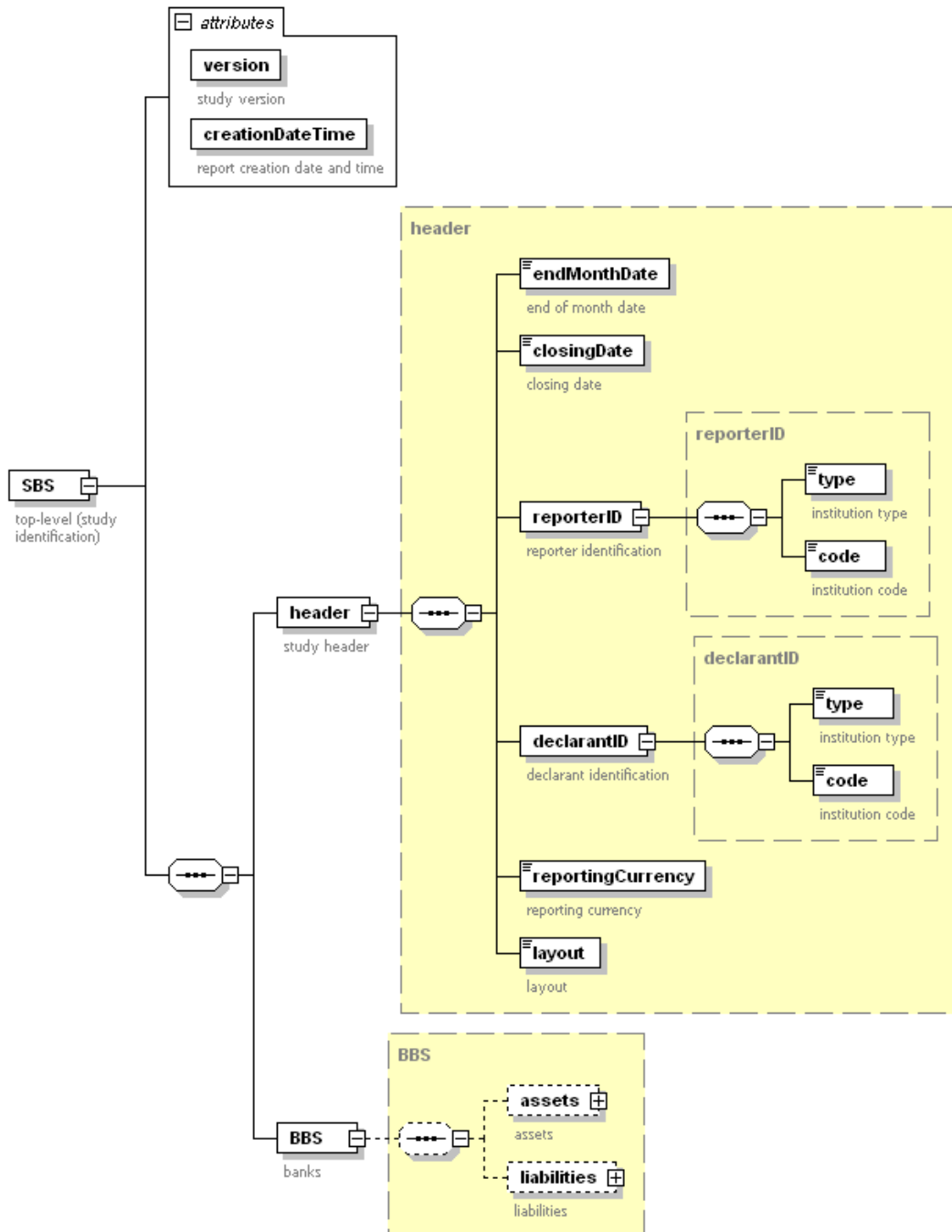

### 3.1.1 The attributes

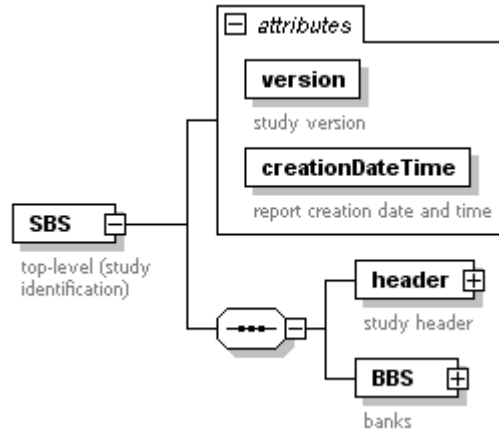

The attribute (*version*) identifies the version of the XML scheme used for the reporting. The attribute (*creationDateTime*) identifies the creation date and the time of the report.

### 3.1.2 The branch Header

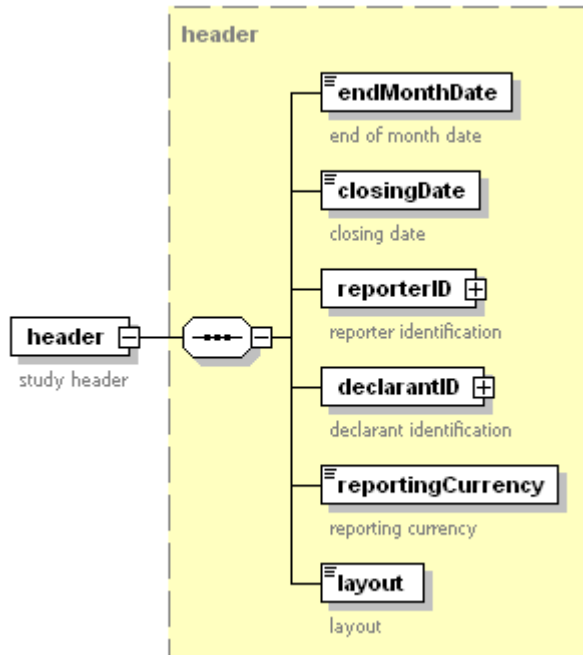

The date of the end of the reference month (*endMonthDate*) corresponds to the last day of the month the data relates to.

The closing date (*closingDate*) corresponds to the date of data compilation.

Example:

For instance, for the security by security reporting of October 2010:

- The end of month date is 31.10.2010
- The closure date may for instance be 29.10.2010

Indeed, since the 31 October 2010 is a Sunday, the data is in principle compiled the last preceding working day, in this case, the 29 October 2010.

The identifications of the reporter (*reporterID*) and of the *declarant* (*declarantID*) include both the type of the identification number (*type*) and the identification number (*code*).

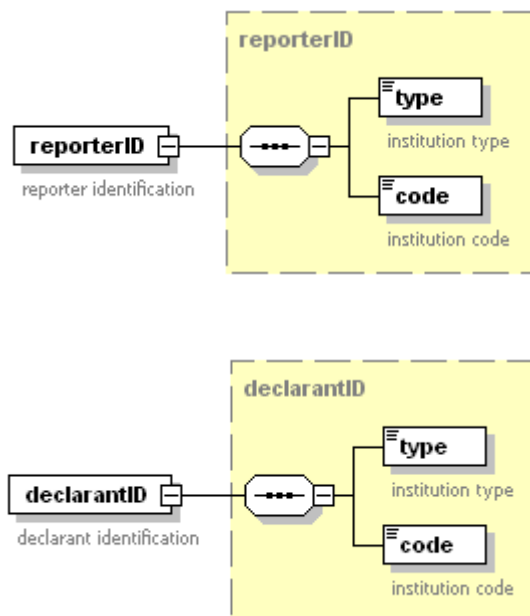

The association of number types and authorised values are:

Type	Code
23	Number allocated by the CSSF to banks

The currency of the reporting (*reportingCurrency*) must be the accounting currency notably the currency used for establishing the balance sheet of the capital - of the credit institution.

The layout (*layout*) indicates the version number of the security by security report. The security by security that enters into force in ~~June 2010~~ **March 2012** will be the ~~second~~ **third** version of this report which means that the layout is «**24**».

### 3.1.33.2 The balance sheet line

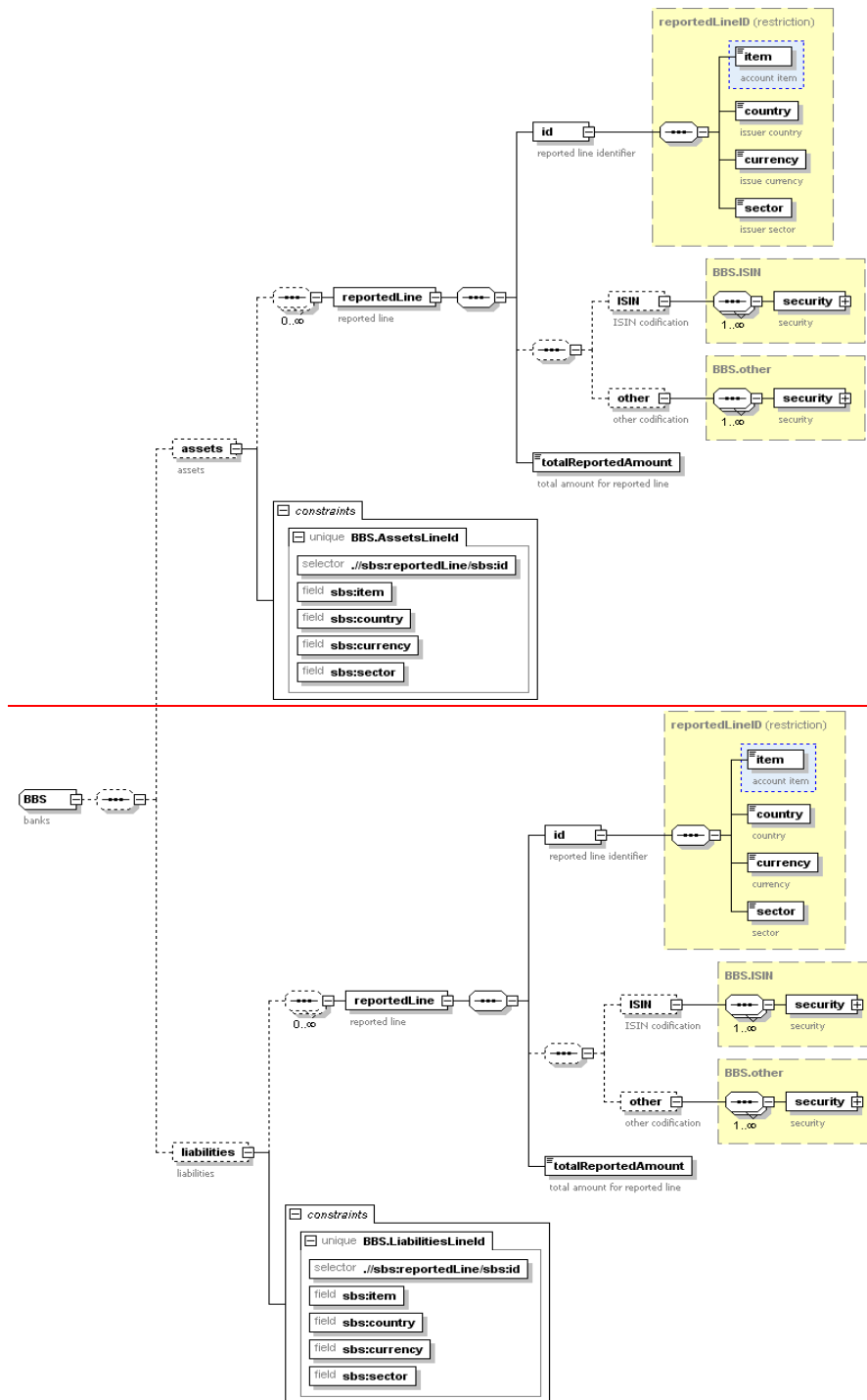

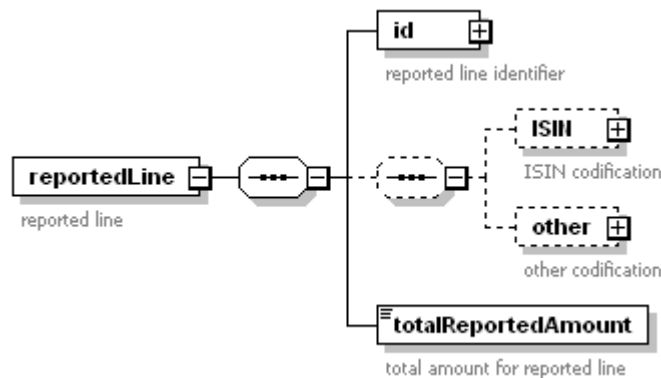

The balance sheet line (*reportedLine*) is identified by the item (*item*), the country (*country*), the currency (*currency*) and the sector (*sector*).

In the XML scheme, the fact that one is located in the branch for assets (~~assets~~) or liabilities restricts the choice of the accounting item (*item*).

Identification of balance sheet line:

- The value taken by the accounting item (*item*) must be:
  - «1» in the case of assets
  - «2» in the case of liabilities
- the country must be coded XX
- the currency must be coded XXX
- the sector must be coded 90000

Reporting agents must refer to the reporting instructions of report S 1.1 «Monthly statistical balance sheet of credit institutions» in order to report only the accounting items as well as the country, currency, sector codes that are requested by the reporting instructions of report S 1.1 «Monthly statistical balance sheet of credit institutions».

The amount reported (*reportedAmount*) corresponds to the amount reported in the balance sheet under the same line identifier. All amounts are expressed in the currency of the balance sheet (*reportingCurrency*).



BANQUE CENTRALE DU LUXEMBOURG

EUROSYSTÈME

The developments of the branches «ISIN» and «Other» are presented in the following paragraphs. These developments follow the same schema for assets (assets) and liabilities

~~(liabilities). In the following lines of the present document only one branch is presented.~~

~~However, the values that are accepted for assets may differ from those accepted for liabilities.~~

### 3.1.43.2.1 Assets

#### 3.2.1.1 Securities identified by an ISIN code

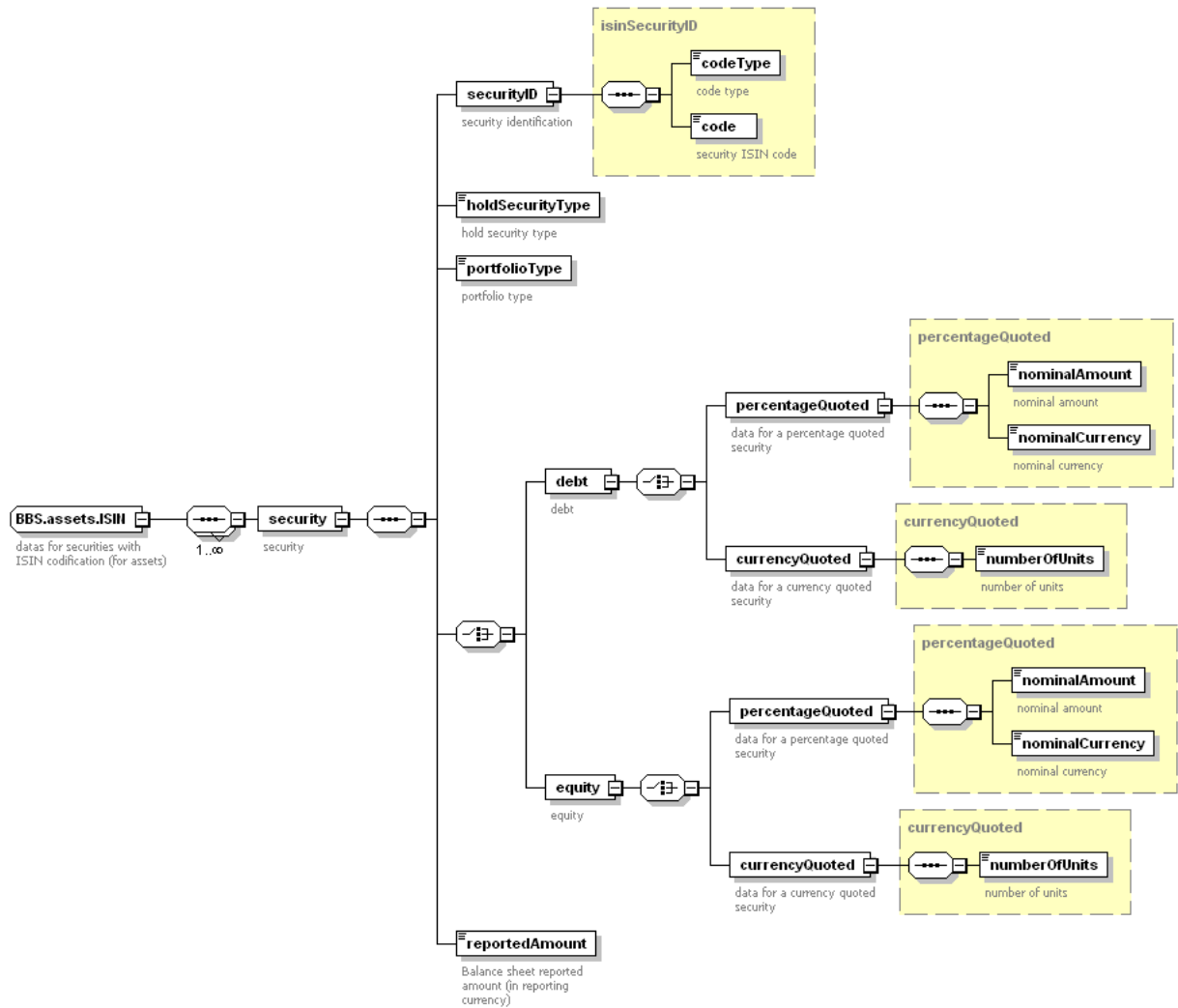

**Securities identified by an ISIN number**

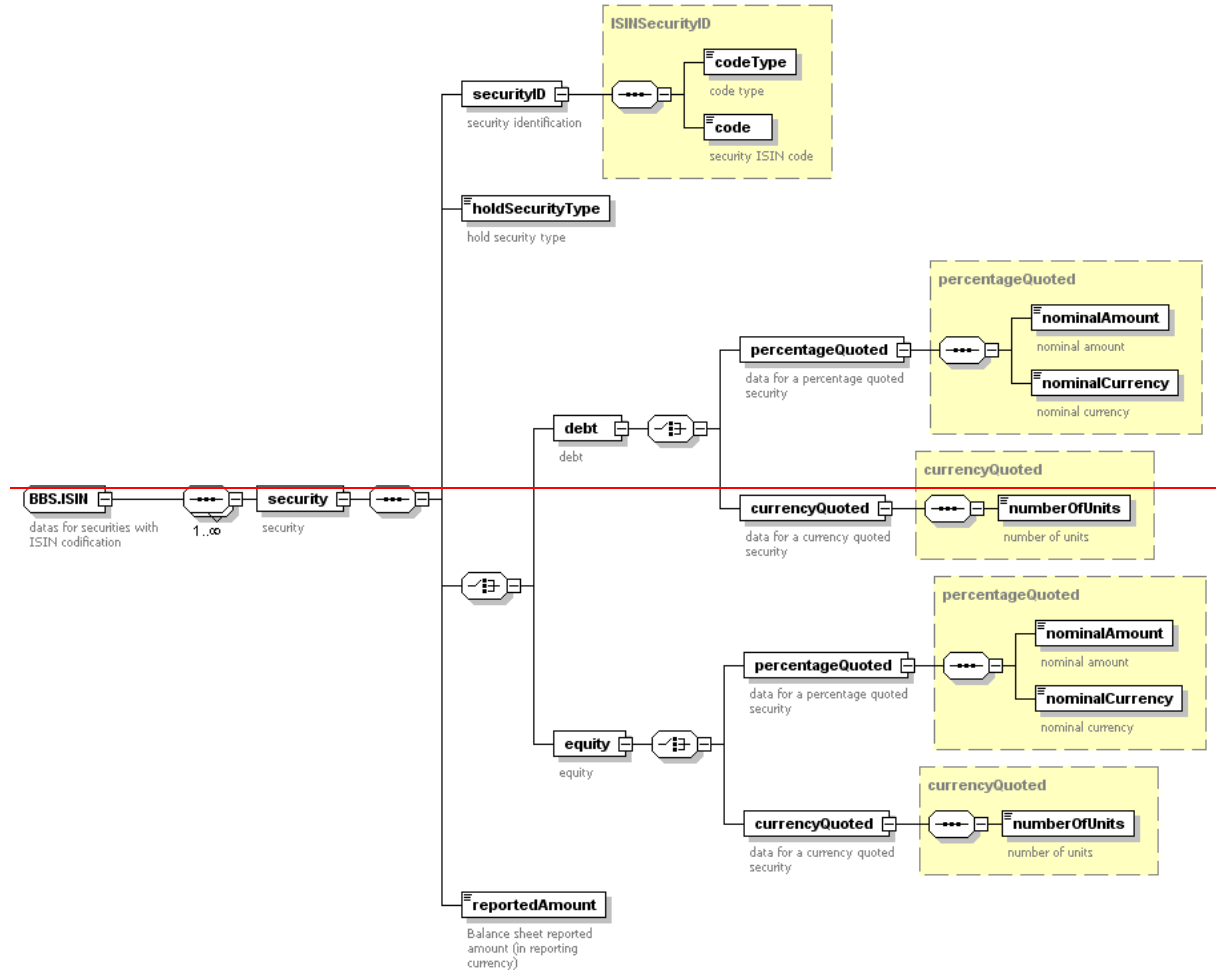

For securities identified by an ISIN **code number**, the security identification (*securityID*) is composed of:

- The type of the code (*codeType*) that takes inevitably the value « 1 »
- The number of the ISIN code

The ISIN **code number** must comply with a given format (2 letters and 9 alphanumeric characters as well as 1 numerical character). The respect of this format is checked through



BANQUE CENTRALE DU LUXEMBOURG

EUROSYSTÈME

the XML scheme. This ISIN ~~code number~~ must also satisfy a control via the check of its digital key.

The type of holding (*holdSecurityType*):

- for assets, the type of detention may only take the values:
  - 01
  - 02
  - 03

The type of portfolio (*PortfolioType*):

- for assets, the type of portfolio may only take the values:
  - 01
  - 02
  - 03
  - 04
  - 05

The nominal amount (*nominalAmount*) is expressed in the currency of the nominal (*nominalCurrency*) according to the ISO 4217 codification.

The number of units (*numberOfUnits*) corresponds to the number of individual securities, regardless of the negotiation quota lot (trading lot).

The reported amount (*reportedAmount*) is expressed in the currency of the balance sheet (*reportingCurrency*). This amount must always be positive.

~~The type of holding (*holdSecurityType*) differs between assets and liabilities:~~

~~•for assets, the type of detention may only take the values:~~

- ~~–01~~
- ~~–02~~
- ~~–03~~

~~•for liabilities, the type of holding may only take the following values:~~

- ~~–04~~
- ~~–05~~



~~The nominal amount (*nominalAmount*) is expressed in the currency of the nominal (*nominalCurrency*) according to the ISO 4217 codification.~~

~~The number of units (*numberOfUnits*) corresponds to the number of individual securities, regardless of the negotiation quota lot (trading lot).~~

~~The reported amount (*reportedAmount*) is expressed in the currency of the balance sheet (*reportingCurrency*). This amount must always be positive.~~

### **3.2.1.2 Securities not identified by an ISIN code**

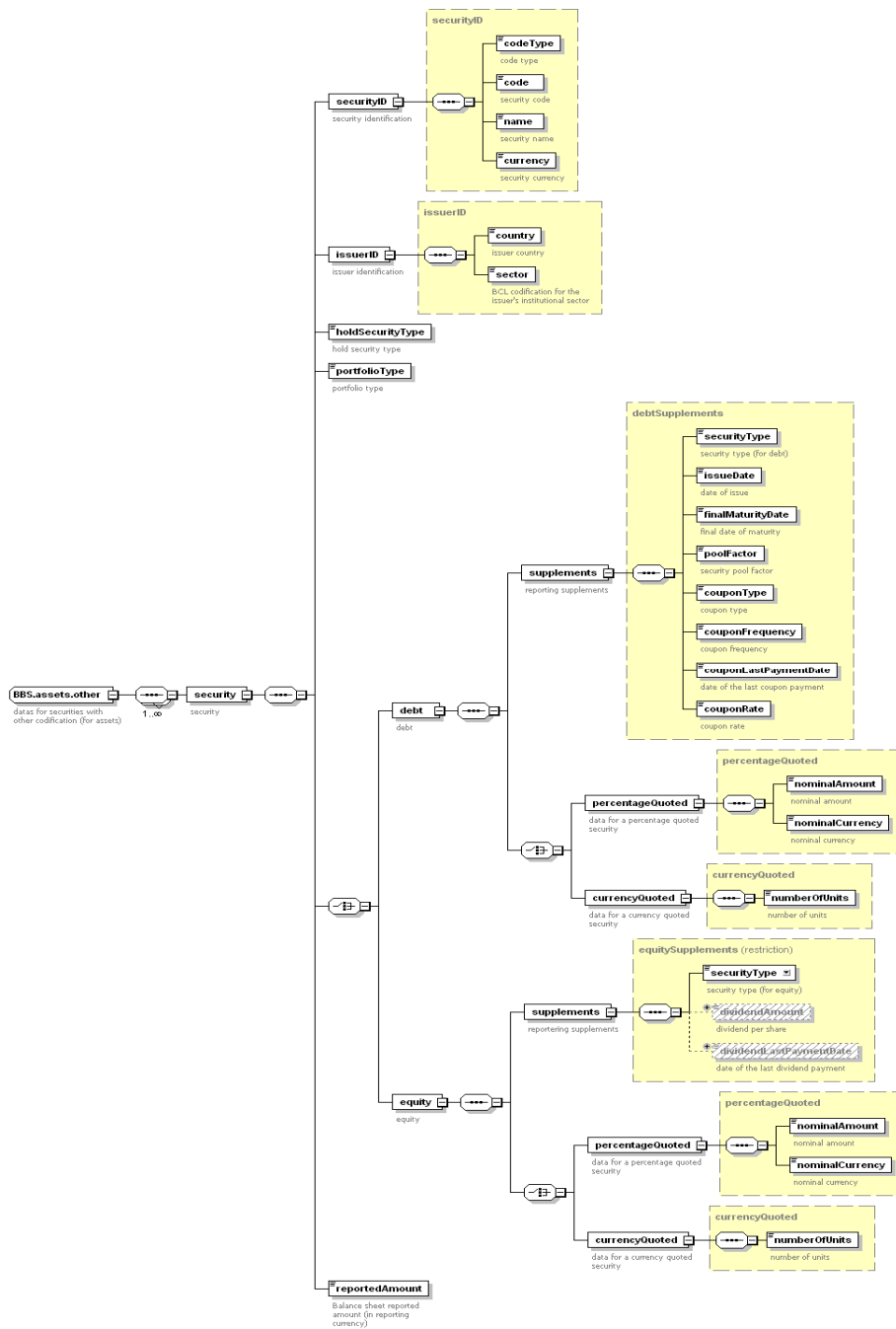

For securities that are not identified by an ISIN code or identified by another code, the security identification (*securityID*) is composed of:

- The type of the code (*codeType*) that takes inevitably the value «2»
- The internal code used by the declarant to identify the security (*code*)
- The name of the security (*name*)
- The currency of the security (*currency*)

The identification of the issuer is based on the following two elements:

- The country of the issuer

The country code of the issuer must be in line with ISO 3166 codification, completed by the specific codes for international institutions as defined by the BCL in the document «Definitions and concepts for the statistical reporting of credit institutions». It is important to mention that the use of code «XX» without breakdown is not permitted.

- The economic sector of the issuer

The economic sector of the issuer must be in line with the list of sectors as defined in the document «Definitions and concepts for the statistical reporting of credit institutions».

It is important to mention that the use of code «90000» without breakdown is not permitted .

The supplementary data for debt securities branch (*debt*):

- The security type (*securityType*) must take the value F.33 for the branch of securities other than shares (*debt*)
- The issue date (*issueDate*) must be prior to the final maturity (*finalMaturityDate*)
- The pool factor represents the percentage of the amounts that remain to be repaid. It is used in the context of securitisation of assets with progressive repayments. Its value is positive or zero. Where the pool factor includes accrued interest, its value could be higher than 1. Its value decreases as repayments occur to 0 at final maturity. For securities repaid only at the final maturity, the value of the pool factor is 1.
- If no coupon payment has occurred, the last coupon payment date (*couponLastPaymentDate*) is the issue date of the security.
- The coupon rate (*couponRate*) is the one in force at the reporting date.

The supplementary data for shares and other equities (*equity*):

- The type of security (*SecurityType*) may take the following values:
  - F.511 for quoted shares
  - F.512 for unquoted shares
  - F.52 for shares/units of UCIs

The type of holding (*holdSecurityType*):

- for assets, the type of detention may only take the values:
  - 01
  - 02
  - 03

The type of portfolio (*PortfolioType*):

- for assets, the type of portfolio may only take the values:
  - 01
  - 02
  - 03
  - 04
  - 05

The nominal amount (*nominalAmount*) is expressed in the currency of the nominal (*nominalCurrency*) according to the ISO 4217 codification.

The number of units (*numberOfUnits*) corresponds to the number of individual securities, regardless of the negotiation quota lot (trading lot).

The reported amount (*reportedAmount*) is expressed in the currency of the balance sheet (*reportingCurrency*). This amount must always be positive.

### **3.1.6 Securities not identified by an ISIN number**

## 3.2.2 Liabilities

### 3.2.2.1 Securities identified by an ISIN number

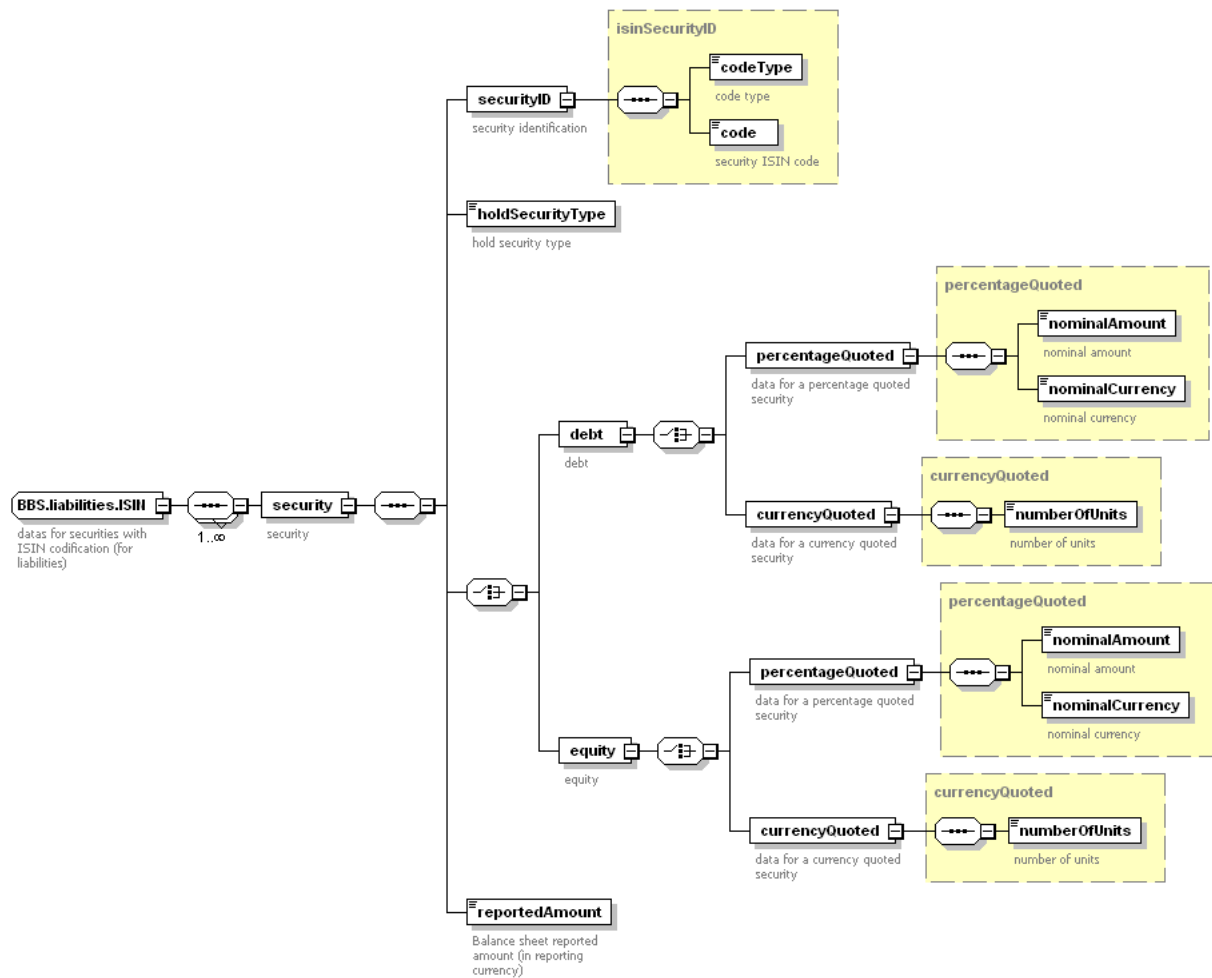

For securities identified by an ISIN code, the security identification (*securityID*) is composed of:

- The type of the code (*codeType*) that takes inevitably the value «1»
- The number of the ISIN code

The ISIN code must comply with a given format (2 letters and 9 alphanumeric characters as well as 1 numerical character). The respect of this format is checked through the XML scheme. This ISIN code must also satisfy a control via the check of its digital key.



The type of holding (*holdSecurityType*):

- for liabilities, the type of holding may only take the following values:
  - 04
  - 05

The nominal amount (*nominalAmount*) is expressed in the currency of the nominal (*nominalCurrency*) according to the ISO 4217 codification.

The number of units (*numberOfUnits*) corresponds to the number of individual securities, regardless of the negotiation quota lot (trading lot).

The reported amount (*reportedAmount*) is expressed in the currency of the balance sheet(*reportingCurrency*). This amount must always be positive.

### 3.2.2.2 Securities not identified by an ISIN code

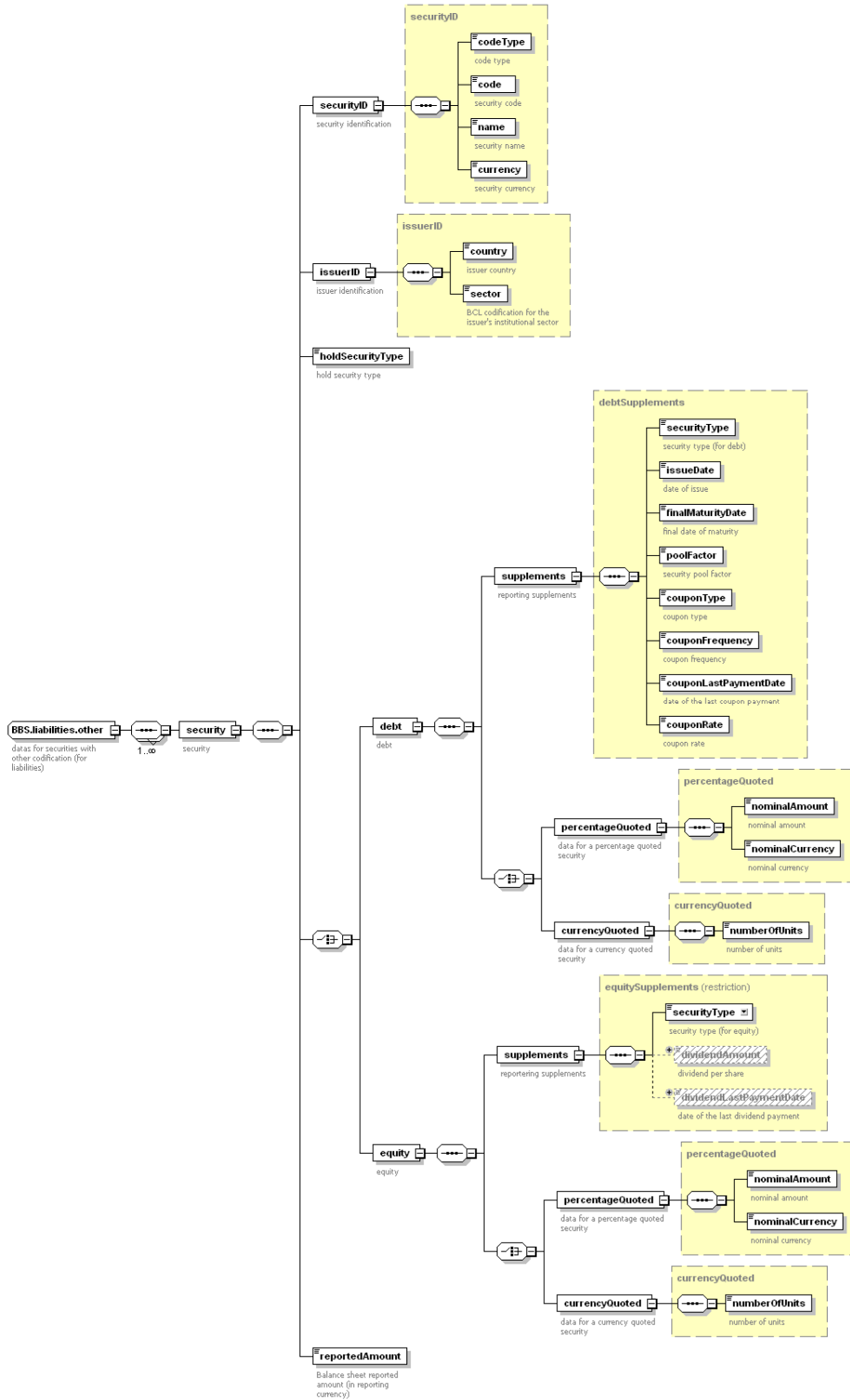

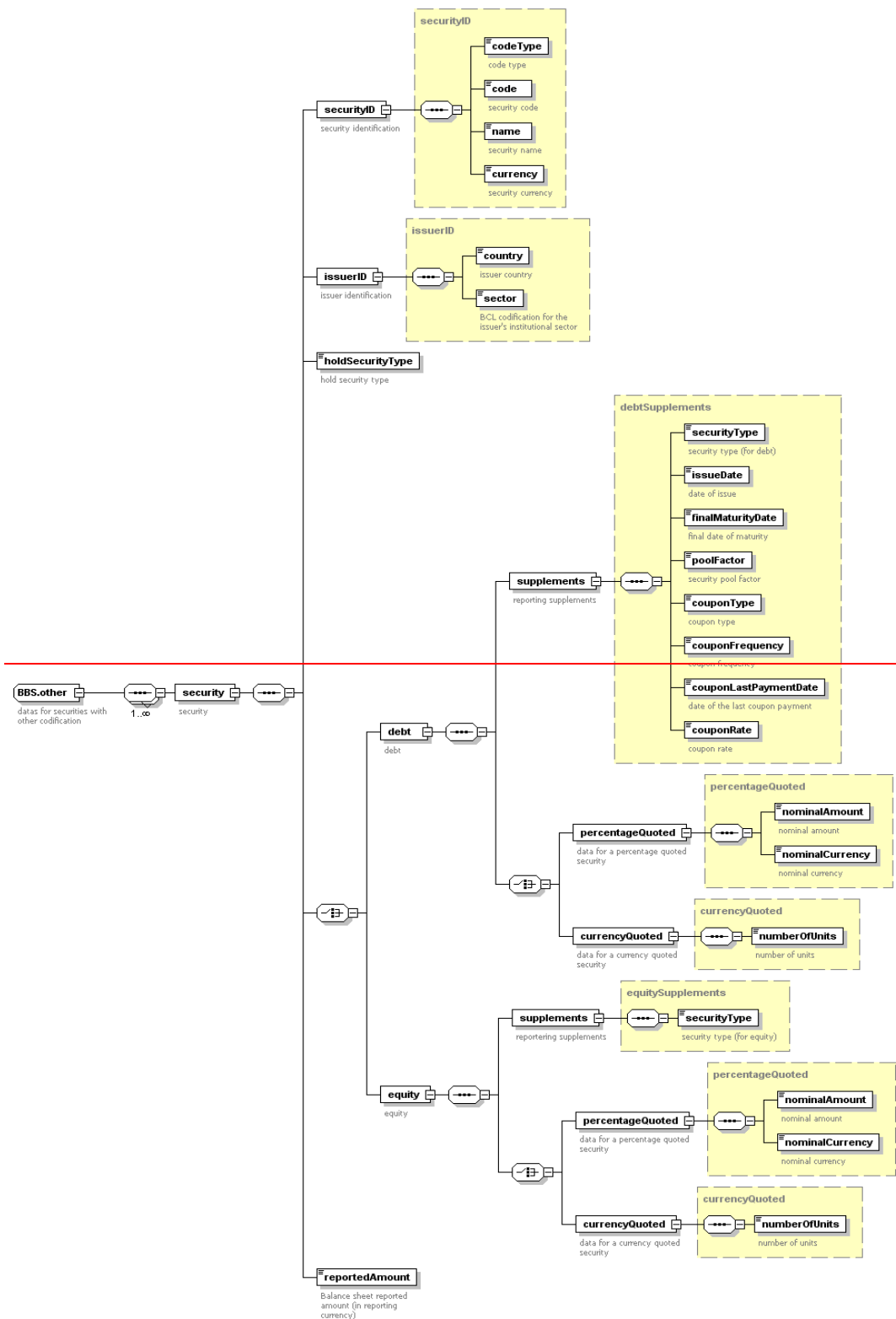

For securities that are not identified by an ISIN code or identified by another code, the security identification (*securityID*) is composed of:

- The type of the code (*codeType*) that takes inevitably the value «2»
- The internal code used by the declarant to identify the security (*code*)
- The name of the security (*name*)
- The currency of the security (*currency*)

The identification of the issuer is based on the following two elements:

- The country of the issuer  
The country code of the issuer must be in line with ISO 3166 codification, completed by the specific codes for international institutions as defined by the BCL in the document «Definitions and concepts for the statistical reporting of credit institutions». It is important to mention that the use of code «XX» without breakdown is not permitted.
- The economic sector of the issuer  
The economic sector of the issuer must be in line with the list of sectors as defined on page 50 in the document «Definitions and concepts for the statistical reporting of credit institutions». It is important to mention that the use of code «90000» without breakdown is not permitted.

For liabilities, if the type of security is «Security issued» (*HoldsecurityType* = 04), the characteristics of the issuer must be:

- Country of the issuer = LU
- Economic sector = 11200

The type of holding (*holdSecurityType*):

- for liabilities, the type of holding may only take the following values:
  - 04
  - 05

The supplementary data for debt securities branch (*debt*):

- The security type (*securityType*) must take the value F.33 for the branch of securities other than shares (*debt*)

- The issue date (*issueDate*) must be prior to the final maturity (*finalMaturityDate*)
- The pool factor represents the percentage of the amounts that remain to be repaid. It is used in the context of securitisation of assets with progressive repayments. Its value is positive or zero. Where the pool factor includes accrued interest, its value could be higher than 1. Its value decreases as repayments occur to 0 at final maturity. For securities repaid only at the final maturity, the value of the pool factor is 1.
- If no coupon payment has occurred, the last coupon payment date (*couponLastPaymentDate*) is the issue date of the security.
- The coupon rate (*couponRate*) is the one in force at the reporting date.

The supplementary data for shares and other equities (*equity*):

- The type of security (*SecurityType*) may take the following values:
  - F.511 for quoted shares
  - F.512 for unquoted shares

~~The type of holding (*holdSecurityType*) differs between assets and liabilities:~~

~~•for assets, the type of detention may only take the values:~~

- ~~–01~~
- ~~–02~~
- ~~–03~~

~~•for liabilities, the type of holding may only take the following values:~~

- ~~–04~~
- ~~–05~~

The nominal amount (*nominalAmount*) is expressed in the currency of the nominal (*nominalCurrency*) according to the ISO 4217 codification.

The number of units (*numberOfUnits*) corresponds to the number of individual securities, regardless of the negotiation quota lot (trading lot).

The reported amount (*reportedAmount*) is expressed in the currency of the balance sheet(*reportingCurrency*). This amount must always be positive.

~~The identification of the issuer is based on the following two elements:~~

~~•The country of the issuer~~

~~The country code of the issuer must be in line with ISO 3166 codification, completed by the specific codes for international institutions as defined by the BCL in the document «Definitions and concepts for the statistical reporting of credit institutions». It is important to mention that the use of code «XX» without breakdown is not permitted.~~

~~•The economic sector of the issuer~~

~~The economic sector of the issuer must be in line with the list of sectors as defined on page 50 in the document «Definitions and concepts for the statistical reporting of credit institutions».~~

~~It is important to mention that the use of code «90000» without breakdown is not permitted.~~

~~For liabilities, if the type of security is «Security issued» (*HoldsecurityType* = 04), the characteristics of the issuer must be:~~

~~•Country of the issuer = LU~~

~~•Economic sector = 11200~~

~~The supplementary data for debt securities branch (*debt*):~~

~~•The security type (*securityType*) must take the value F.33 for the branch of securities other than shares (*debt*)~~

~~•The issue date (*issueDate*) must be prior to the final maturity (*finalMaturityDate*)~~

~~•The pool factor represents the percentage of the amounts that remain to be repaid. It is used in the context of securitisation of assets with progressive repayments. Its value is positive or zero. Where the pool factor includes accrued interest, its value could be higher than 1. Its value decreases as repayments occur to 0 at final maturity. For securities repaid only at the final maturity, the value of the pool factor is 1.~~

~~•If no coupon payment has occurred, the last coupon payment date (*couponLastPaymentDate*) is the issue date of the security.~~



•The coupon rate (*couponRate*) is the one in force at the reporting date.

The supplementary data for shares and other equities (*equity*):

•The type of security (*SecurityType*) may take the following values:

–F.511 for quoted shares

–F.512 for unquoted shares

–F.52 for shares/units of UCIs

#### 4 Format of variables in the XML file

Variables	xml format	Maximum	Pattern / Facets	Example
creationDateTime	datetime		YYYY-MM-DDThh:mm:ss	2010-10-29T23:59:59
<u>header</u>				
-endMonthDate	date		YYYY-MM-DD	2010-10-31
-closingDate	date		YYYY-MM-DD	2010-10-29
-reporterID/type	string	2 characters	[0-9]{2}	23
-reporterID/code	string	30 characters		999
-declarantID/type	string	2 characters	[0-9]{2}	23
-declarantID/code	string	30 characters		999
-reportingCurrency	string	3 characters	[A-Z]{3}	EUR
<u>reportedLine/Id</u>				
-item	string	5 characters	[1-3]-[0-9A-Z]{3}	1-030
-country	string	2 characters	[A-Z]{2} ou X[AZ0-9]	XX
-currency	string	3 characters	[A-Z]{3} ou XX[A-Z0-9]	XXX
-sector	string	5 characters	[0-9]{5}	90000
<u>reportedLine/ISIN</u>				
-securityID/codeType	integer		1, 2	1
-securityID/code	string	12 characters	[A-Z]{2}[A-Z0-9]{9}[0-9]{1}	US870200CA83



Variables	xml format	Maximum	Pattern / Facets	Example
-holdSecurityType	string	2 characters	[0-9]{2} 01, 02, 03, 04, 05	01
portfolioType	string	2 characters	[0-9]{2} 01, 02, 03, 04, 05	01
-percentageQuoted/nominalAmount	decimal	5 decimals		1000000
-percentageQuoted/nominalCurrency	string	3 characters	[A-Z]{3}	USD
-currencyQuoted/numberOfUnits	decimal	5 decimals		7000
-reportedAmount	decimal	5 decimals		1234567.89012
<u>reportedLine/other</u>				
-securityID/codeType	integer		1, 2	2
-securityID/code	string	20 characters		CD0001
-securityID/name	string	1024 characters		Certificat dépôt 1.5% 10/2010
-securityID/currency	string	3 characters	[A-Z]{3}	USD
-issuerID/country	string	2 characters	[A-Z]{2}	US
-issuerID/sector	string	5 characters	[0-9]{5}	42220
-holdSecurityType	string	2 characters	[0-9]{2} 01, 02, 03, 04, 05	01
-percentageQuoted/nominalAmount	decimal	5 decimals		1000000
-percentageQuoted/nominalCurrency	string	3 characters	[A-Z]{3}	USD

Variables	xml format	Maximum	Pattern / Facets	Example
-currencyQuoted/numberOfUnits	decimal	5 decimals		7000
-reportedAmount	decimal	5 decimals		1234567.89012
<u>-debt/supplements</u>				
—securityType	string	5 characters	F.33	F.33
—issueDate	date		YYYY-MM-DD	2005-03-31
—finalMaturityDate	date		YYYY-MM-DD	2025-03-31
—poolFactor	percentage	9 decimals	>= 0	1
—couponType	string	2 characters	[0-9]{2} 01, 02, 03, 04, 05, 99	01
—couponFrequency	string	2 characters	[0-9]{2} 01, 02, 03, 04, 06, 12, 24, 99	01
—couponLastPaymentDate	date		YYYY-MM-DD	2009-06-30
—couponRate	decimal	9 decimals		3.125
<u>-equity/Supplements</u>				
—securityType	string	5 characters	F.511, F.512, F.52	F.511
totalreportedAmount	decimal	5 decimals		25562485.256

- The *datetime* format is used to specify a date and a time: YYYY-MM-DDThh:mm:ss  
where:  
YYYY indicates the year, MM indicates the month, DD indicates the day  
T indicates the start of the required time section  
hh indicates the hour, mm indicates the minute, ss indicates the second
- The *date* format is used to specify a date: YYYY-MM-DD  
where:  
YYYY indicates the year, MM indicates the month, DD indicates the day

Detailed information on xml standard is available on the web site under the following address: <http://www.w3schools.com/>